

方形工业换气扇

高转速 风量大 噪音低



用于工厂、厨房、办公楼、酒楼及娱乐场所等通风换气

方形工业换气扇

【产品品牌】德通

【额定电压】220V / 380V

【产品转速】1400RPM

【产品风量】510~8700m³/h

【产品功率】28~600W

【产品噪音】53~75dB

【商品产地】中国广东

【适用场所】工厂、厨房、办公楼、酒楼及娱乐场所

【备注】预留线长30厘米左右（产品出厂不附带插头）

【产品型号】8寸、10寸、12寸、14寸、16寸、20寸、24寸、7种型号



性能数量 电源电压：D指示220V,S指示380V（注：风量（m³/min）60分钟x8.5=510）

型号	规格	额定电压	功率	转速	风量	噪音	重量
	(mm/inch)	(V)	(W)	(RPM)	(m ³ /min)	(dB)	(Kg)
FAD20-4	200/8"	220	28	1400	8.5	53	2
FAD25-4	250/10"	220	28	1400	13	55	2.4
FAD30-4	300/12"	220	45	1400	20	58	3.8
FAD35-4	350/14"	220	75	1400	30	65	4.5
FAD40-4	400/16"	220	145	1400	48	67	7.7
FAS40-4	400/16"	380	145	1400	48	67	7.1
FAD50-4	500/20"	220	350	1400	95	70	13
FAS50-4	500/20"	380	350	1400	95	70	11.5
FAD60-4	600/24"	220	600	1400	145	75	15
FAS60-4	600/24"	380	600	1400	145	75	14.8

外形结构图

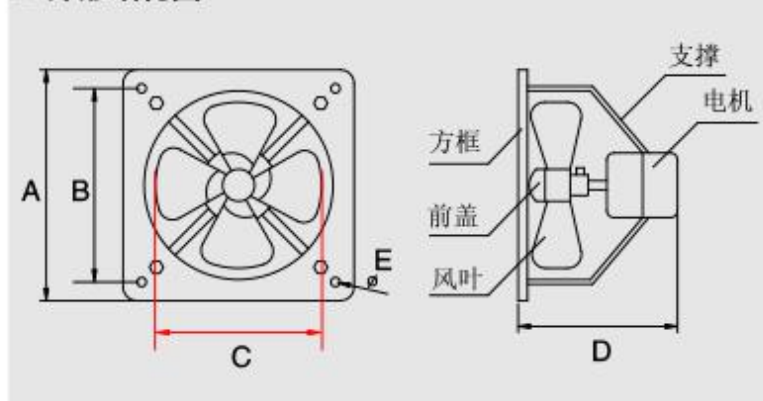

外形尺寸 (单位mm)

型号	A	B	C	D	E
FAD20-4	230	197	200	125	12
FAD25-4	284	245	250	145	12
FAD30-4	355	302	300	155	12
FAD35-4	415	329	350	178	12
FAD40-4	480	378	400	220	12
FAS40-4	480	378	400	180	12
FAD50-4	600	479	500	270	15
FAS50-4	600	479	500	230	15
FAD60-4	700	542	600	285	18
FAS60-4	700	542	600	238	18

注：图例中B所指的是产品（安装尺寸）。



官方旗舰店

好风扇 德通造

FA 系列方形工业换气扇

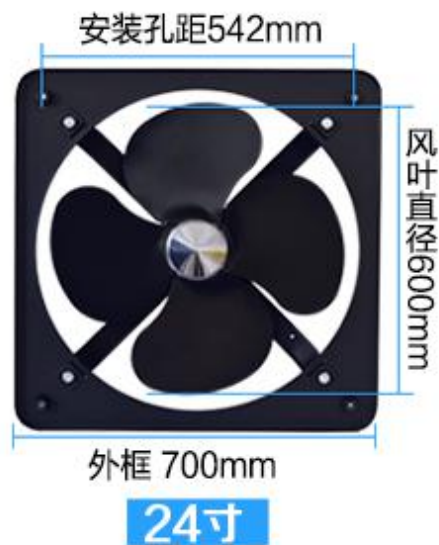
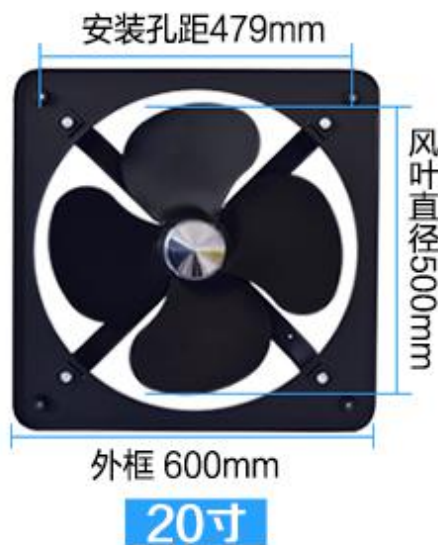
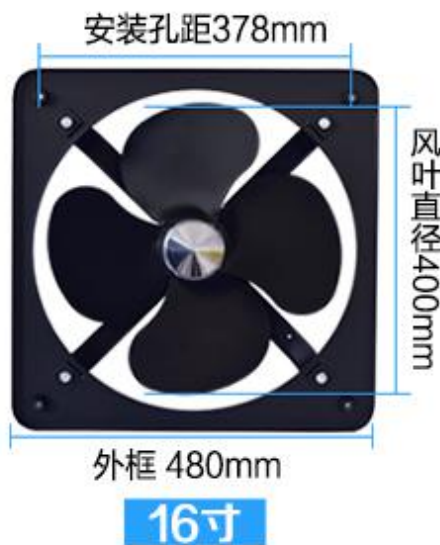
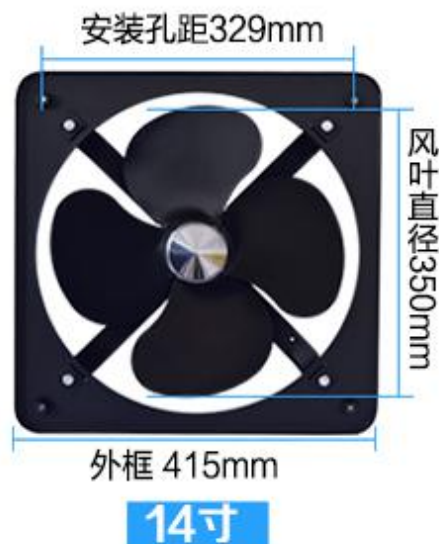
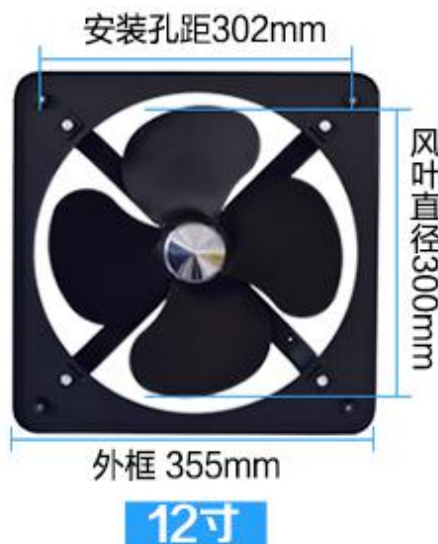
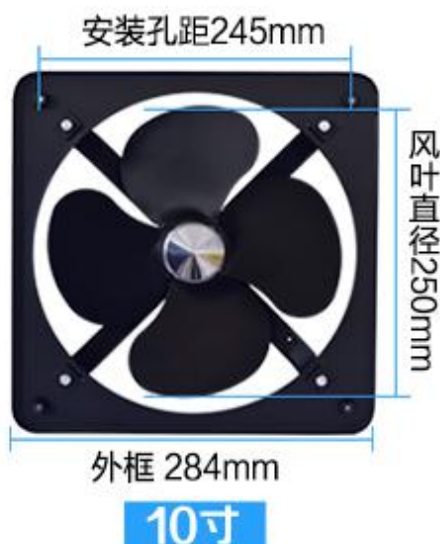
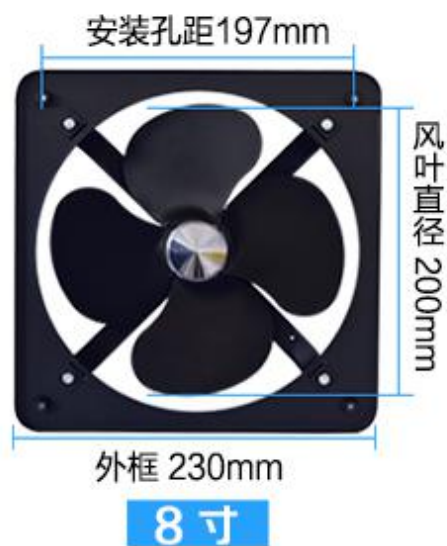



方形工业换气扇

FA Series Rectangular Ventilating Fan

全金属面板机身，结构零件采用优质钢板冲压而成，广泛用于工业、仓库车间等娱乐场所通风换气

方形工业换气扇

FA Series Rectangular Ventilating Fan

纯铜电机，风量大、低噪音滚动轴承，风力强径，运行平稳





方形工业换气扇

FA Series Rectangular Ventilating Fan

结构零件采用优质薄钢板

冲压而成

方形工业换气扇

FA Series Rectangular Ventilating Fan

刚性好、美观大方、易于安装

风叶用料十足，坚固耐用 寿命长





方形工业换气扇

FA Series Rectangular Ventilating Fan

电机采用冲压外壳，润滑
性能强，电机运行寿命长，
高效节能

外包装设计



全密封滚动电机

优质滚珠轴承，噪音低、运行稳定

DET ON FAN

FA SERIES SQUARE
E INDUSTRIAL EXHAUST FAN

