

BGS-Z 系列

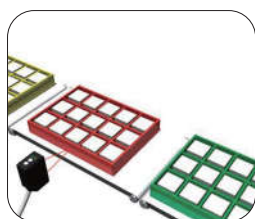

- 低成本，高性能产品！
- 设计紧凑，性能优越！
- BGS（背景抑制）型传感器不受背景颜色的干扰。
- 结构坚固，可承受 100G 冲击力，防护等级 IP67。

应用示例



各颜色托盘的检出
(BGS-Z30N)

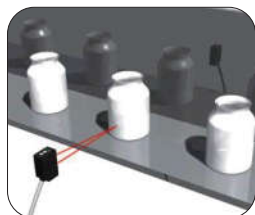

抑制不锈钢背景的干扰
(BGS-Z30N)

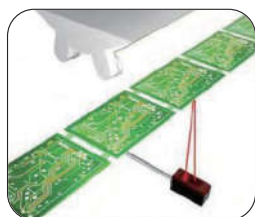

PCB
(BGS-Z30N)

500 us 快速响应

适合检测快速移动物体。

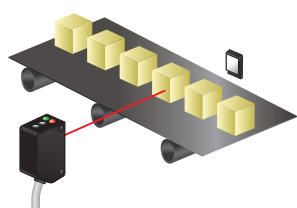

高功率窄角 LED 光束

高功率发射的 LED 光在明亮环境下依然清晰可见，以便安装。



四圈电位调节器

内置四圈电位器可实现灵敏度的细微调整。
电位器设有滑动离合器，可避免电位器转过头。



宽光斑

BGS 型传感器 LED 发射光斑直径 6mm，避免受 PC 板小孔的干扰。
针对孔眼较大的 PC 板，可使用光斑直径 18mm 的 BGS-Z30 传感器。

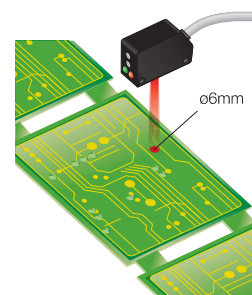

C-R

C2

DM-18T

E

J

J2

J3

K

S

BGS-2S

BGS-Z

Z2

Z3

ZM

V

V2

V3

V4

选购件

参数

类型	长距离		中距离		短距离	
	2m 电缆式	M8 QD 4 针 接插式	2m 电缆式	M8 QD 4 针 接插式	2m 电缆式	M8 QD 4 针 接插式
类型	BGS-Z30N	BGS-Z30CN	BGS-Z15N	BGS-Z15CN	BGS-Z10N	BGS-Z10CN
NPN	BGS-Z30P	BGS-Z30CP	BGS-Z15P	BGS-Z15CP	BGS-Z10P	BGS-Z10CP
设定距离	50 - 300 mm (*1)		20 - 150 mm		20 - 100 mm (*1)	
检测距离	10 - 300 mm (*1)		5 - 150 mm		5 - 100 mm (*1)	
响应时间	500μs					
光斑尺寸	φ30mm / 300mm		φ10mm / 150mm		φ10mm / 100mm	
滞后现象	5%		4%		3%	
常开 / 常闭模式	常开 (入光动作) / 常闭 (遮光动作) 模式可选					
LED 指示灯	输出: 橘色, 稳定: 绿色					
光源	红色 LED					
灵敏性调节	四圈循环式电位器					
开关量输出	NPN/PNP 集电极开路, ≤100mA/ 30V DC					
电源电压	DC 10 ~ 30V ±10%					
消耗电流	30mA max					
防护等级	IP 67					
耐冲击	100G (1,000m/S ²)					
环境照度	阳光≤10,000 勒克斯 (lux), 白炽灯照射≤3,000 勒克斯 (lux)					
环境温度 / 湿度	-25 ~ +55°C / 35 ~ 85%RH					
材质	ABS (壳体), PMMA (镜头)					

用于欧洲标准的 M8 QD 3 针接插式型传感器, 其型号后缀有 CN(P)3, 如“ZR-QX200CN3”。

*1 白纸: 100 x 100mm

尺寸

BGS 型

输出指示灯 (橘色)
LED 型: 稳定指示灯 (绿色)

灵敏度调节器
常开 / 常闭切换键

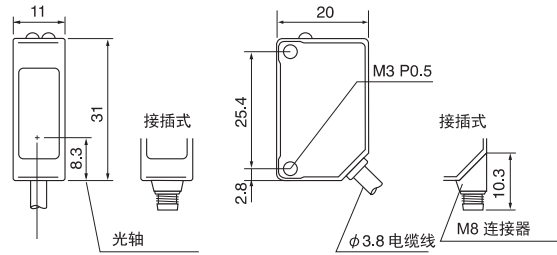

4 针配置

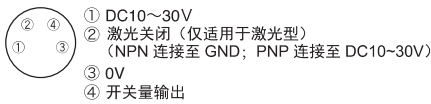

BEF-W100-A 标准支架
M8 QD 接插式传感器配件

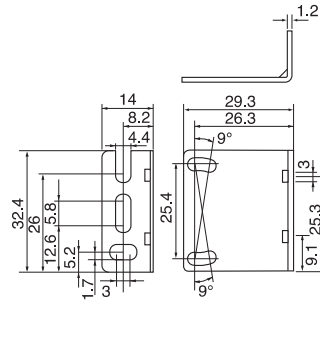

BEF-W100-B 标准支架
电缆式传感器配件

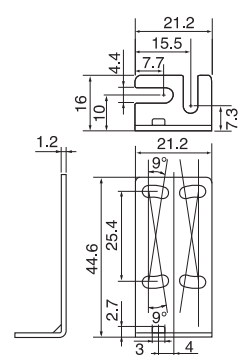

(单位: mm)

电路图

NPN 输出

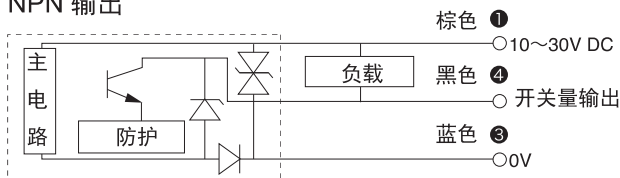

对射型发射器

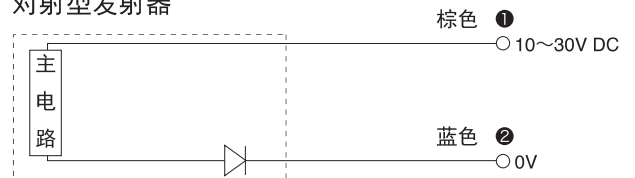

PNP 输出

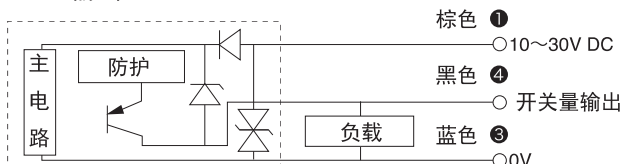

选购件

JCN-S: M8 直线型



JCN-S : 2 m
JCN-5S : 5 m
JCN-10S : 10 m

JCN-L: M8 直角型



JCN-L : 2 m
JCN-5L : 5 m
JCN-10L : 10 m

安装保护支架
LK-S01



LK-S02



BL-100-POLF: 防相互干扰
适用于 ZT-1200



特性图 (参考)

BGS-Z30

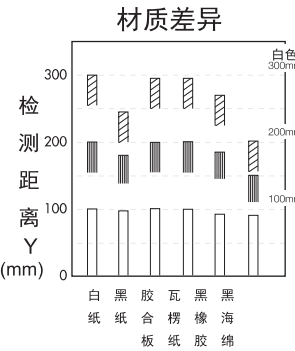
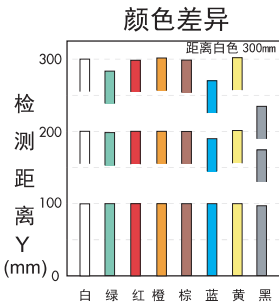
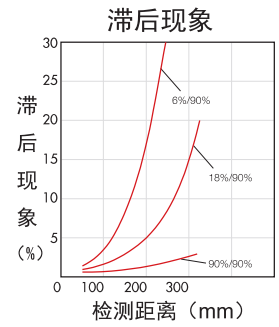
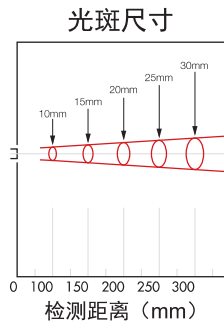
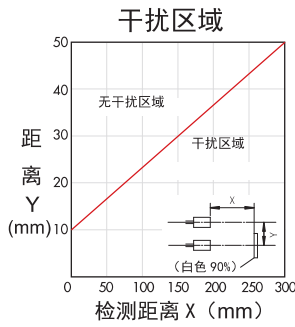
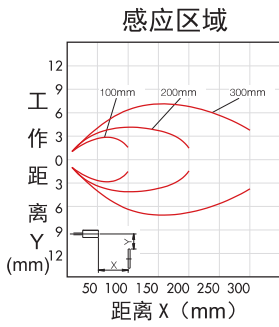

BGS-Z10

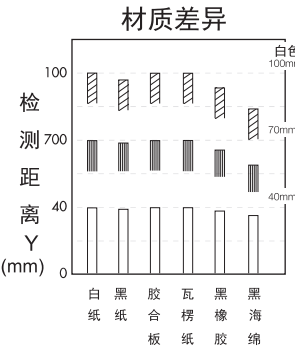
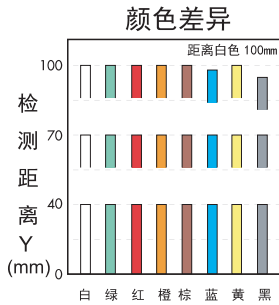
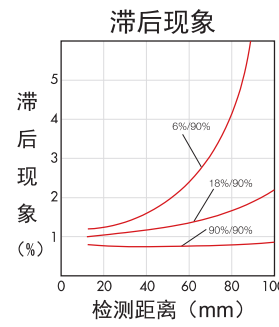
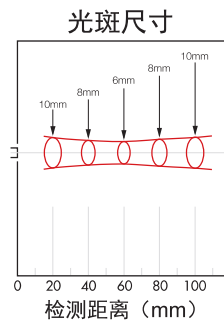
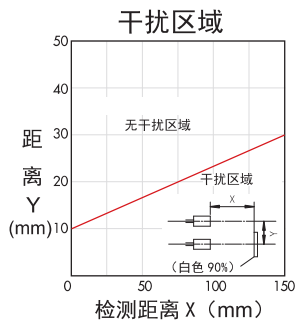
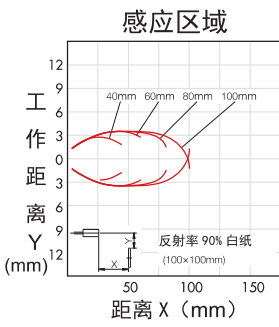

- C-R
- C2
- DM-18T
- E
- J
- J2
- J3
- K
- S
- BGS-2S
- BGS-Z**
- Z2
- Z3
- ZM
- V
- V2
- V3
- V4
- 选购件