

K系列



- 极适用于检测玻璃/PET瓶等透明体（KR-Q50/KR-Q150/KR-Q300）。
- 内置安装螺母，以便安装。
- 不锈钢外壳，防止受撞击损坏，防护等级IP67。

应用示例



传送带上的PET瓶检测



托盘上的PET瓶检测



PET瓶计数

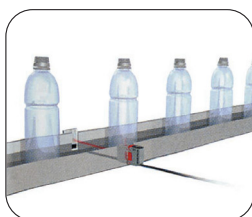

狭小空间内检测PET瓶

不锈钢外壳

不锈钢外壳可保护传感器，避免因外物撞击损伤。



内置安装螺母

内置安装螺母可避免因螺丝过紧损坏外壳的问题，且可使安装更为方便快捷。

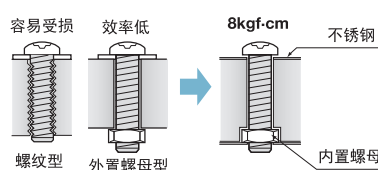

抗电气噪音性能 优于VDE标准要求

内部电路防噪音干扰功能严格按VDE标准设计。同时，经内部Feilen噪音测试验证，产品防噪音功能稳定可靠，符合国际标准要求。

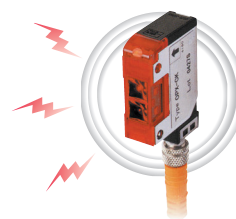

本体结构

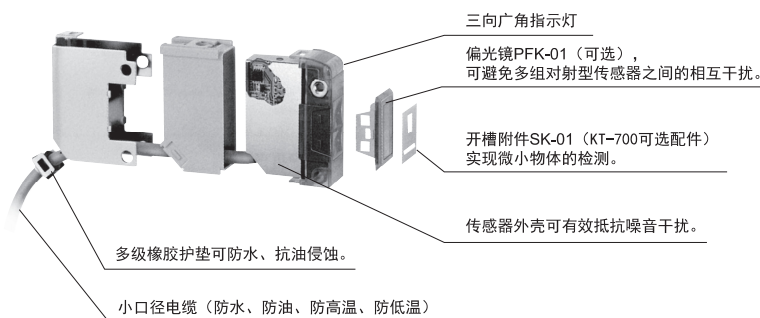

C-R

C2

DM-18T

E

J

J2

J3

K

S

BGS-2S

BGS-Z

Z2

Z3

ZM

V

V2

V3

V4

选购件

电路图

NPN 输出

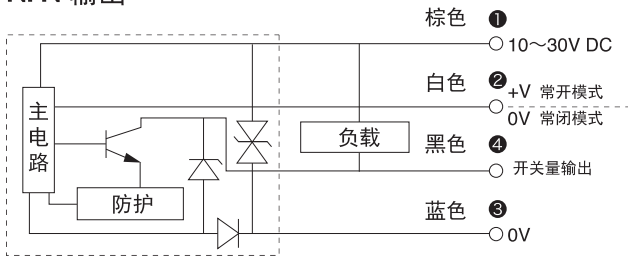

对射型发射器

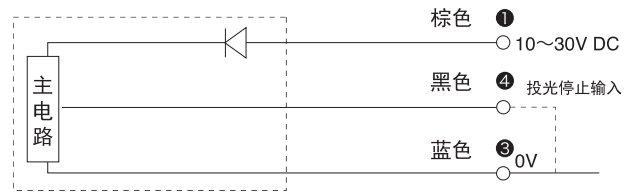

尺寸

电缆式

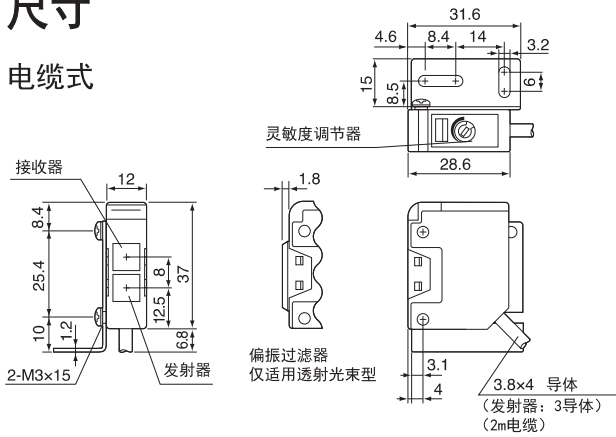

接插式

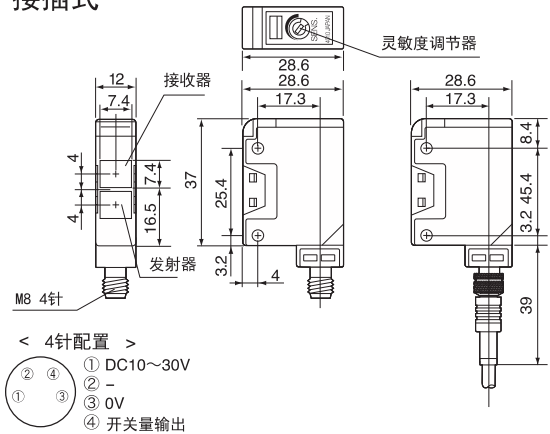

标准型反射器V-61

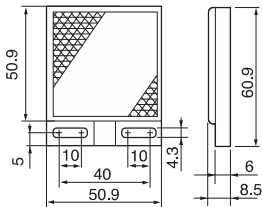

小型反射器V-42

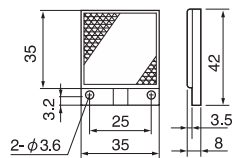

微型反射器P-45

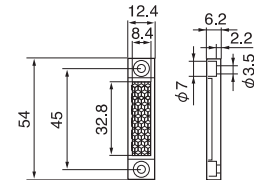

BEF W170

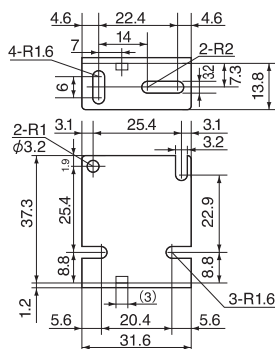

JCN-S: M8直线型

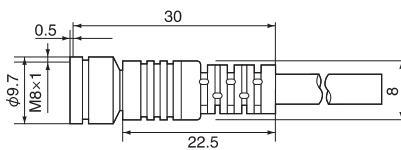

JCN-L: M8直角型

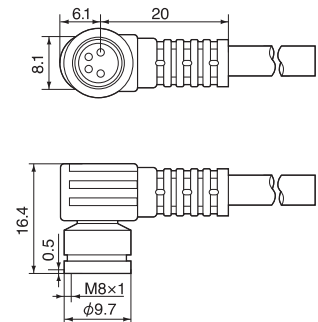

(单位: mm)

参数

类型		对射型	镜面反射型 带偏光镜	漫反射型	限定反射型	透明体检测型		
电缆式	NPN	KT-700N	KR-250N	KD-40N	KD-L09N	KR-Q50NW	KR-Q150NW	KR-Q300NW
	PNP	KT-700P	KR-250P	KD-40P	KD-L09P	KR-Q50PW	KR-Q150PW	KR-Q300PW
接插式	NPN	KT-700CN	KR-250CN	KD-40CN	KD-L09CN	KR-Q50CNW	KR-Q150CNW	KR-Q300CNW
	PNP	KT-700CP	KR-250CP	KD-40CP	KD-L09CP	KR-Q50CPW	KR-Q150CPW	KR-Q300CPW
检测距离		7 m	2.5 m	40 cm	1 - 9 cm	50 cm	1.5 m	3 m
光源		红色LED						
最小检测物		φ7mm	—	φ40mm	—	φ2.5mm (钢丝)		
响应时间		1msec Max	0.7msec Max					
滞后现象		—		20% Max	10% Max	—		
灵敏度调节		—		单圈电位器				
LED指示灯		1个指示灯						
开光量输出		NPN或PNP 集电极开路, ≤100mA/ 30V DC						
投光停止输入		外部输入						
常开/常闭模式		常开 (入光动作) / 常闭 (遮光动作) 模式可选						
绝缘电阻		Min. 20M Ohm / DC 500V						
电源电压		DC 10~30V ±10%						
消耗电流		35mA Max	30mA Max					
认证		JIS, UL, CE, VDE						
工作温度/湿度		-25~+55°C / 35~85%RH						
环境照度		阳光≤10,000 勒克斯 (lux), 白炽灯照射≤3,000勒克斯 (lux)						
抗震动		10~55Hz振幅 1.5mm, X-Y-Z, 各两小时						
防护等级		IEC 144 IP67, VDE Level 3						
材料		ABS (壳体), PC (镜头), SUS304 (面板)						
重量 (净重)		25g (对射型发射器20g)						25g

选购件

标准型反光镜V-61



小型反光镜V-42



微型反光镜P-45



JCN-S: M8直线型



JCN-S : 2 m
JCN-5S : 5 m
JCN-10S : 10 m

JCN-L: M8直角型



JCN-L : 2 m
JCN-5L : 5 m
JCN-10L : 10 m

安装保护支架
LK-S01



LK-S02



传感器立式支架
PLN-1
反光镜安装支架
PLN-1M



开槽配件: SK-01

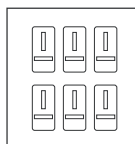

滤光片: PFK-01



	开槽SK-01 (发射器+接收器)	带偏光镜	开槽+滤光片
检测距离	1000mm	1000mm	500mm
最小光斑直径	φ1mm	φ7mm	φ1mm

※将背部胶带撕开后黏在传感器镜头上即可。

- C-R
- C2
- DM-18T
- E
- J
- J2
- J3
- K
- S
- BGS-2S
- BGS-Z
- Z2
- Z3
- ZM
- V
- V2
- V3
- V4
- 选购件

特性图 (参考)

KR-Q300NW

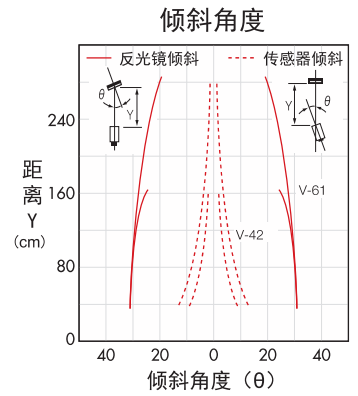
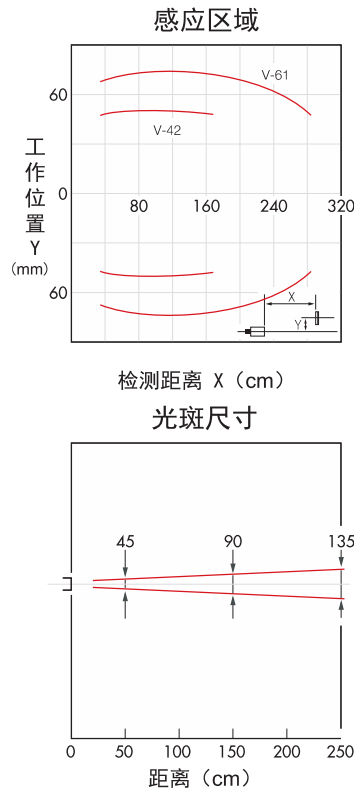
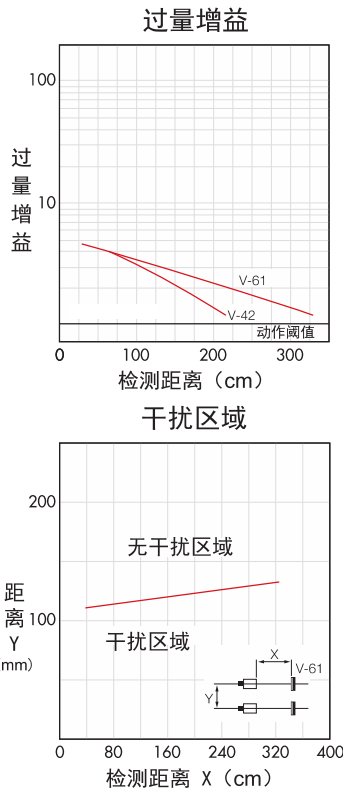

KR-Q150NW

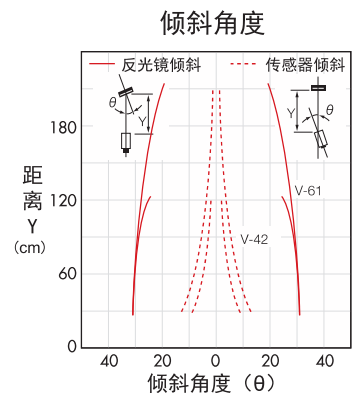
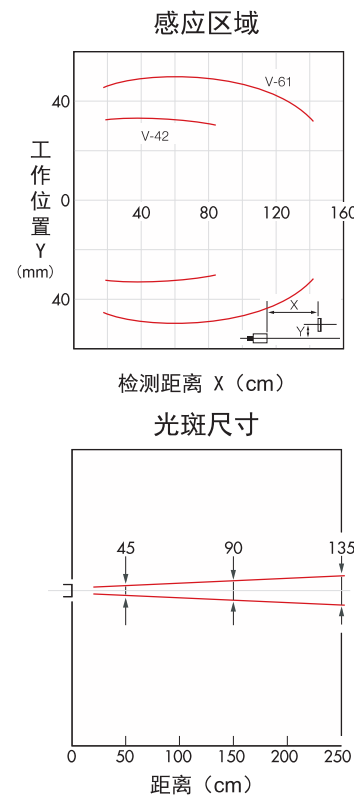
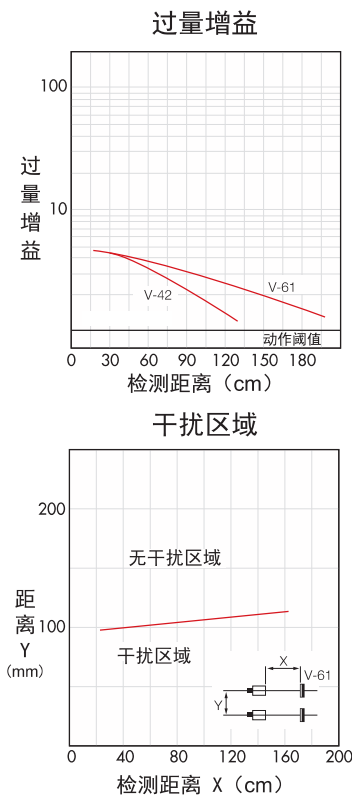

- C-R
- C2
- DM-18T
- E
- J
- J2
- J3
- K**
- S
- BGS-2S
- BGS-Z
- Z2
- Z3
- ZM
- V
- V2
- V3
- V4
- 选购件

特性图 (参考)

KR-Q50NW

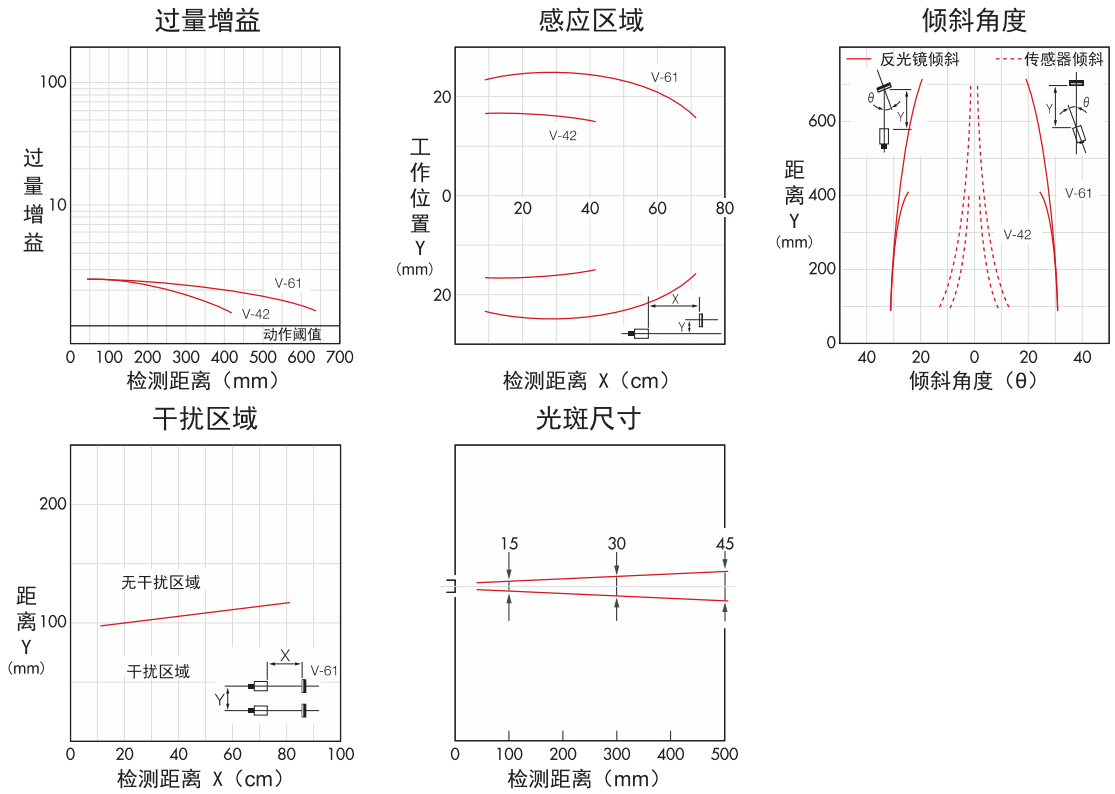

KR-Q50N

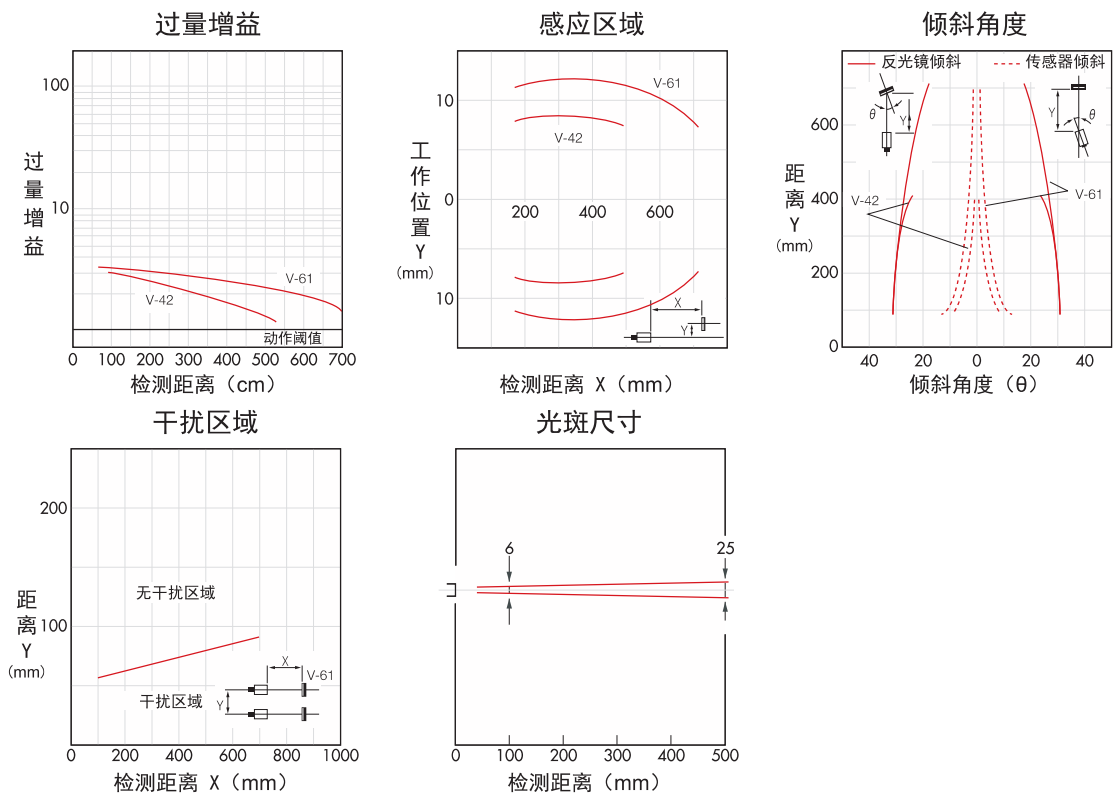

C-R

C2

DM-18T

E

J

J2

J3

K

S

BGS-2S

BGS-Z

Z2

Z3

ZM

V

V2

V3

V4

选购件